

Environmental Measurement Japan, CO., LTD.

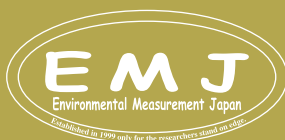

2-52-42 Takamidai, Fukuoka-city Higashiku, Fukuoka 811-0215, Japan
TEL +81-92-608-6412
FAX +81-92-985-7844

MIJ-12 Waterproof Data Logger Manual

Environmental Measurement Japan

MIJ-12 Preheat Version: How to wiring

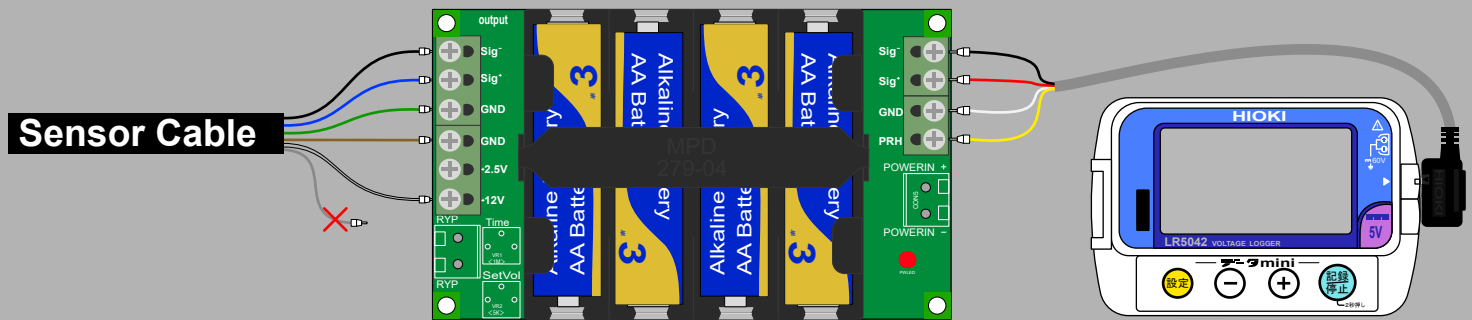

Wire	PR-01
●	Sig ⁻
●	Sig ⁺
●	GND
●	PRH

Typical sensor that require preheat

Soil Moisture Snesors

SM150T or ML3

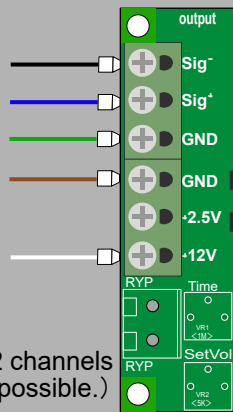
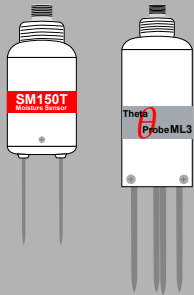

(temperature measurement requires 2 channels, so temperature measurement is not possible.)

EC-5, 10HS or TEROS10

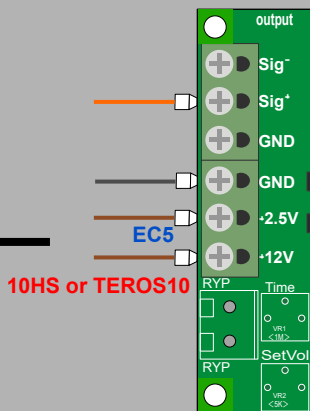
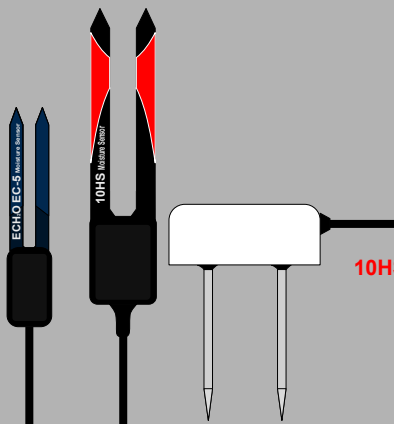

*Please do not connect EC5 to 12V port.

*EC5 will be broken if you connctet to 12 V port

Dendrometers

MIJ-02 Type3 Rotary

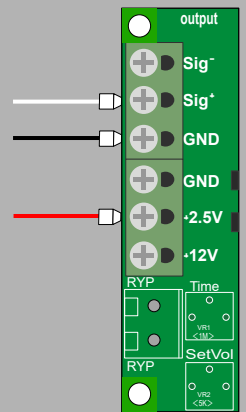
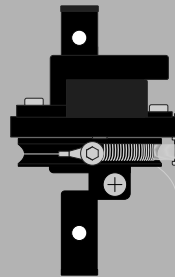

MIJ-02 Type2 Series (LM, LMS and LMM)

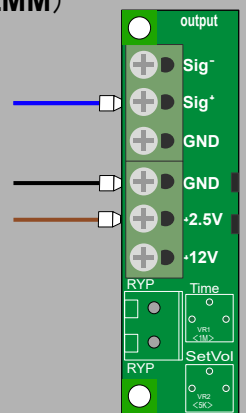
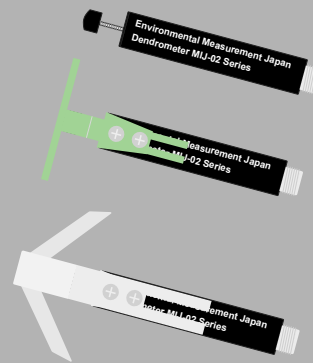

Environmental Measurement Japan, CO., LTD.

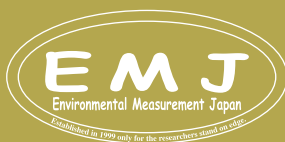

PR-01 Sensor Preheat Power Supply Board

PR-01 is a board that supplies the necessary voltage to the sensor from four AA batteries. We offer a standard type that outputs two types of voltages, [2.5 & 12V] and a type that outputs two types of voltages, [5 & 12V], so you can choose according to the voltage required by the sensor you are connecting. The instantaneous output capacity is 80mA. For most sensors, except for some temperature and humidity sensors, which have a particularly long start-up time after turning the power on, a preheat time of 1 second is sufficient. An interval of 10 to 30 minutes provides a good balance between battery life and the number of data. The capacity of an AA alkaline battery is 2000mAh, so it can operate the sensor for more than a year in an environment ranging from 0 to 50 degrees. We recommend using AA (AA) lithium batteries, especially when using in low-temperature environments. In this case, the battery capacity is about 3000mAh.

SM150T、ML3、EC5、10HS etc

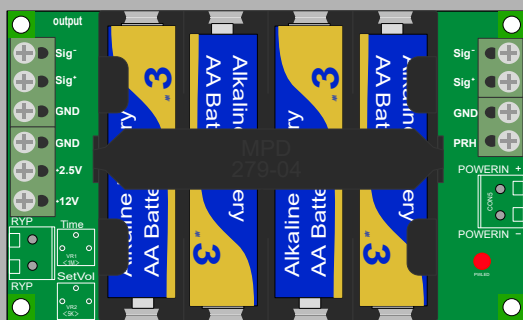

Outputs two voltages: [2.5V or 12V]

EMJ Dendrometer

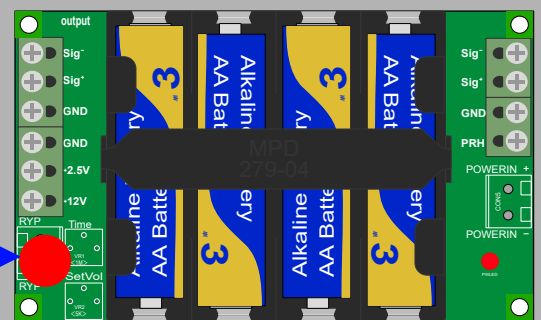

Outputs two voltages: [5V or 12V]

There is a red sticker on the base.

MIJ-12 Preheat-less Version: How to wiring

How to wire the sensor (do not require preheat) to MIJ-12 preheat-less model. Since it does not require preheating, the PR-01 board is not required.

Sensor Cable

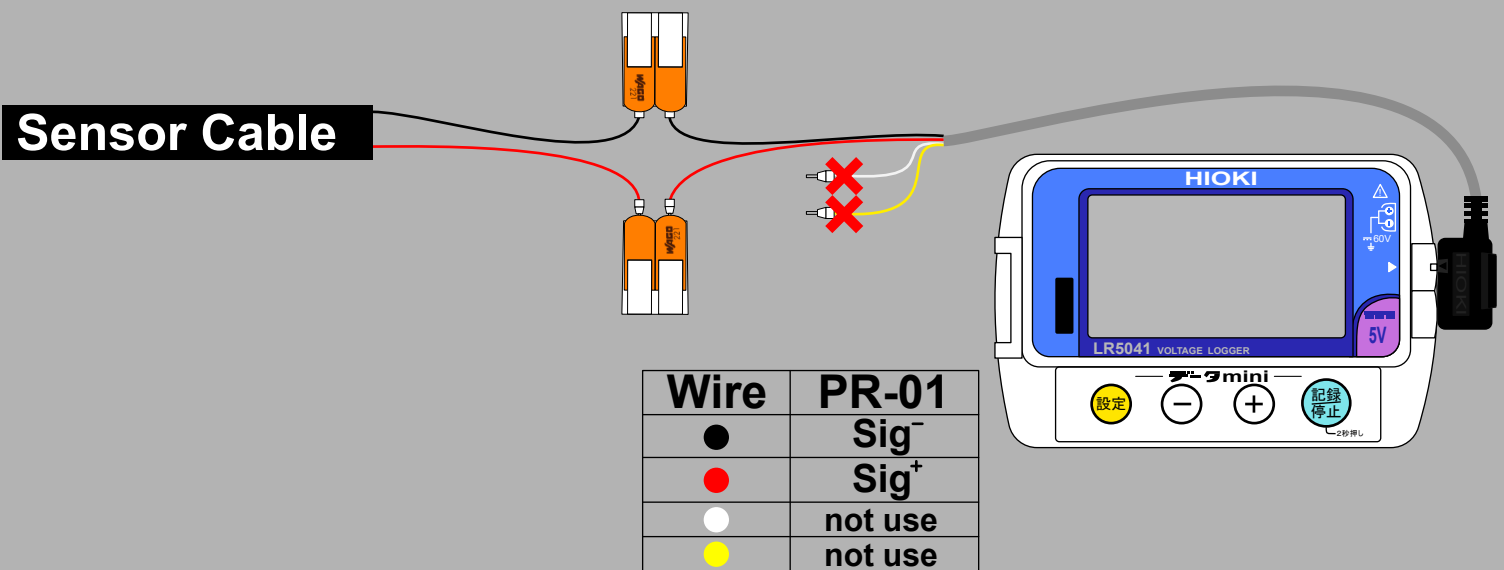

Typical sensor that do not require preheat

PAR Sensor

MIJ-14/K2 (without amplifier)

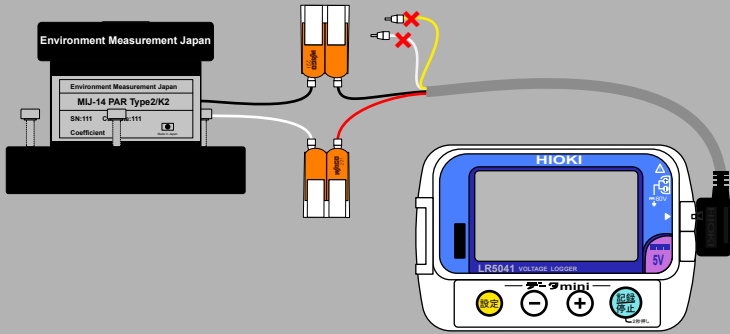

Soil Oxygen Sensor

MIJ-03

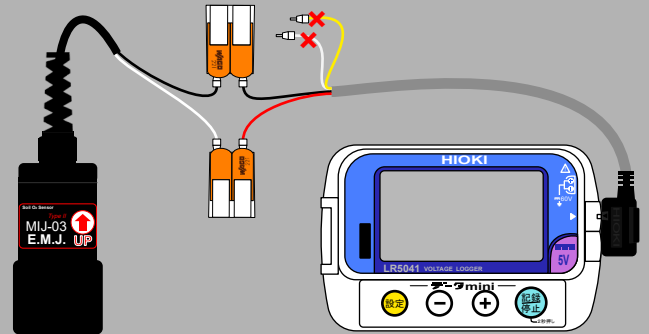

Caution

When using the MIJ-12 in the field, please note the following:

Open the zipper as shown below and put the zip bag into the MIJ-12. There is no need to remove the silica gel from the zip bag.

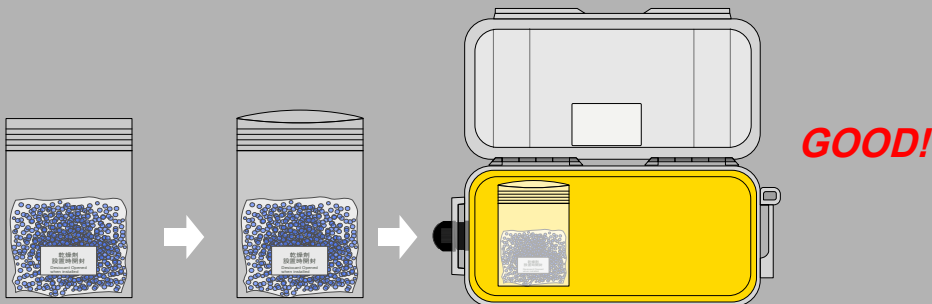

The following is an incorrect way to put silica gel in. If you take out the contents and put it back in, the effect of the silica gel will be extremely short.

It's time to replace the silica gel when its color changes from blue to pink.

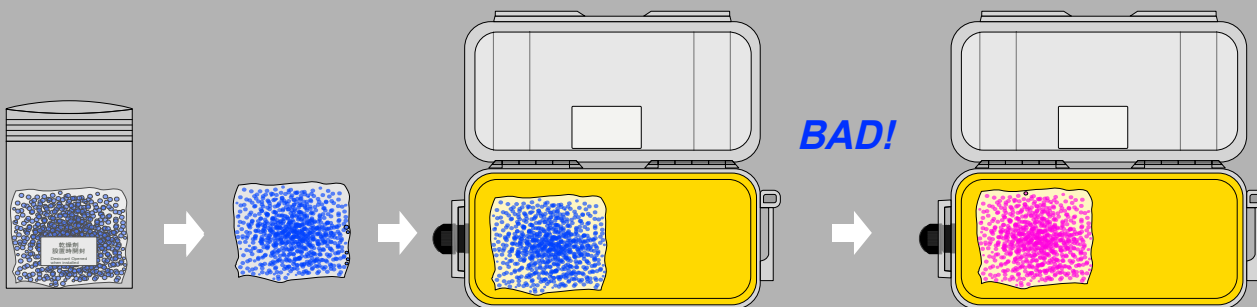

Blue color will be pink color in short periods

MIJ-12 Waterproof Data Logger Manual

Environmental Measurement Japan

When using the MIJ-12 in the field, please note the following:

There have been cases where the lid of the MIJ-12 was closed with the cable still in place, causing water to get into the case and destroying the PR-01 and data logger.

• When closing the lid, please make sure that no cables are pinched before installing it (this applies not only to cables, but also to silica gel bags and other items).

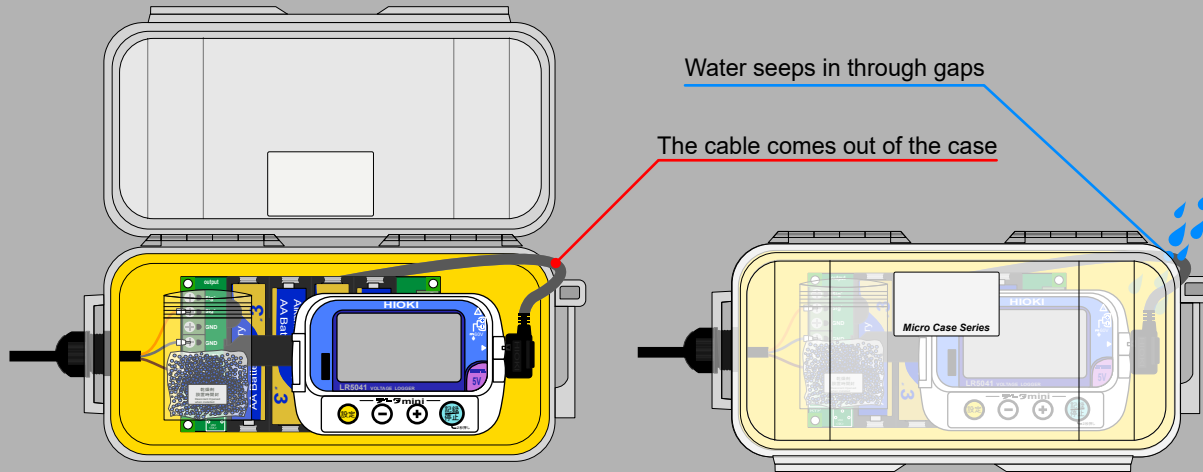

Since the MIJ-12 is waterproof, many people use it outdoors. Some people may work outdoors, collect the data on-site, and then put the lid back on, but you need to be careful of sand and mud. If the lid gets caught in foreign objects, it can cause water to get in. Before closing the lid on-site, wipe off any sand or mud that has adhered to the lid and the yellow rubber with a wet cloth before putting the lid back on.

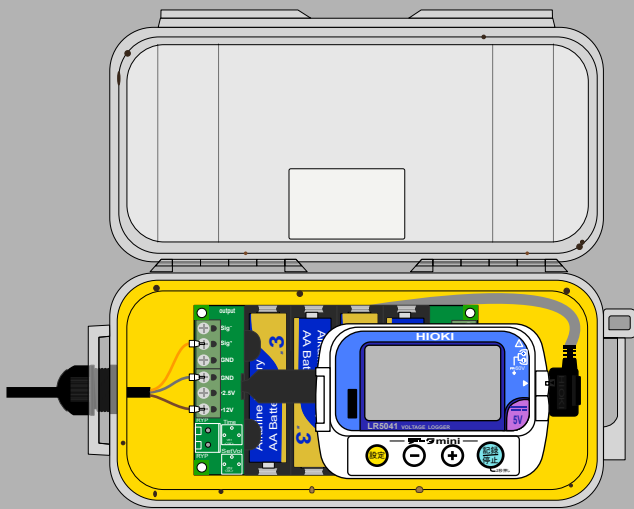

GOOD!



As long as there is no dirt or other contaminants on the lid and rubber, it will function properly as a waterproof container.

BAD! Causes of flooding

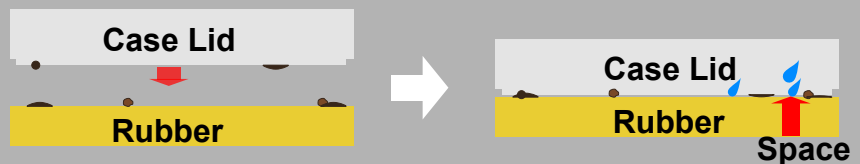

If mud or sand (including dust and lint) is on the lid or rubber parts, a small gap will form between the lid and the rubber parts. Even a gap that is invisible to the naked eye can allow water to get in.

Before use, be sure to wet the cloth (wring it out tightly) to remove any dirt. Do not use microfiber cloth to prevent fibers stick to the rubber and allow water to seep in.

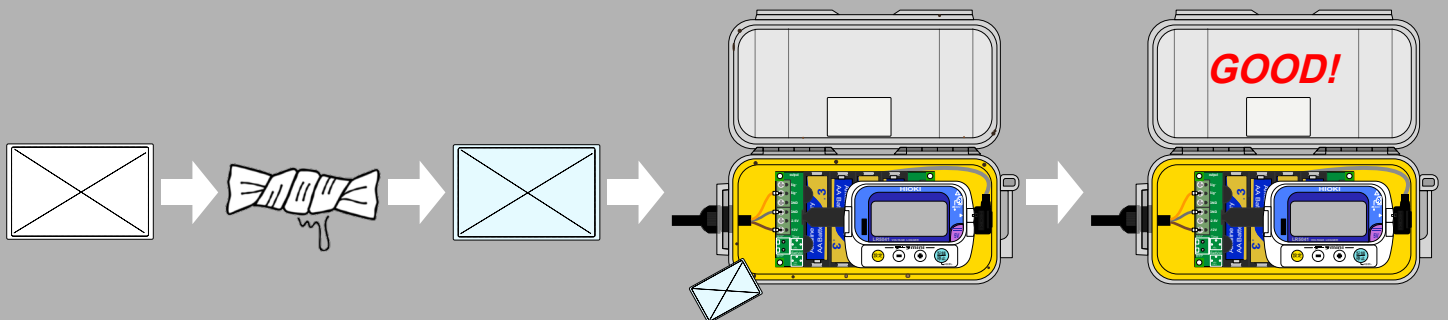

Environmental Measurement Japan, CO., LTD.

5.

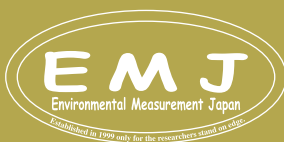

2-52-42 Takamidai, Fukuoka-city Higashiku, Fukuoka 811-0215, Japan
 TEL +81-92-608-6412
 FAX +81-92-985-7844

Data Logger 5041 or 5042 how to set

The following settings are made at the time of shipment.

- Rec interval : 10min
- Start Method : Button Operation
- Stop Method : Button Operation(one-time)
- Rec Mode : Instantaneous
- Preheat : ON/OFF from [Measurement Method] tab

* Generally, we do not recommend making any changes other than to the rec interval.

1.

Insert the communications adapter LR5091 or LR5092 into the USB port of your PC (refer to the HIOKI manual for instructions on how to install the driver, etc.).

You can search on web (searching word HIOKI LR5091 or HIOKI 5042)

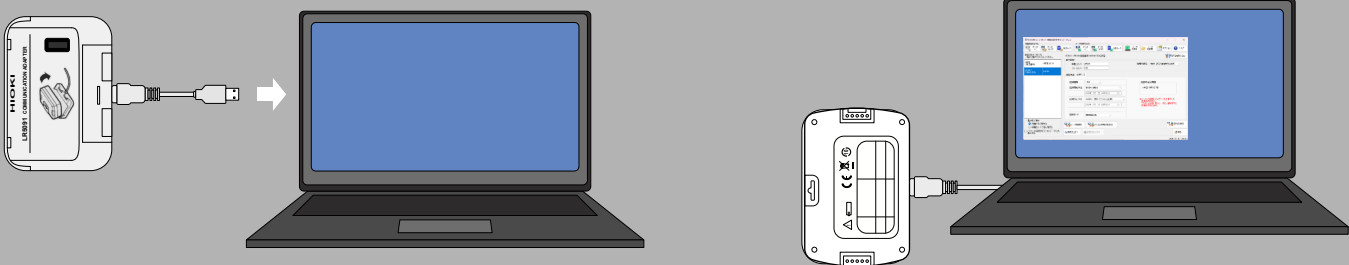

2.

The LR5000 Utility screen will be displayed on your PC. Change any of the settings in the Recording Method tab. When changing the settings, be sure to check the available recording time. The shorter the recording interval, the shorter the available recording time. For more information, please see the instruction manual.

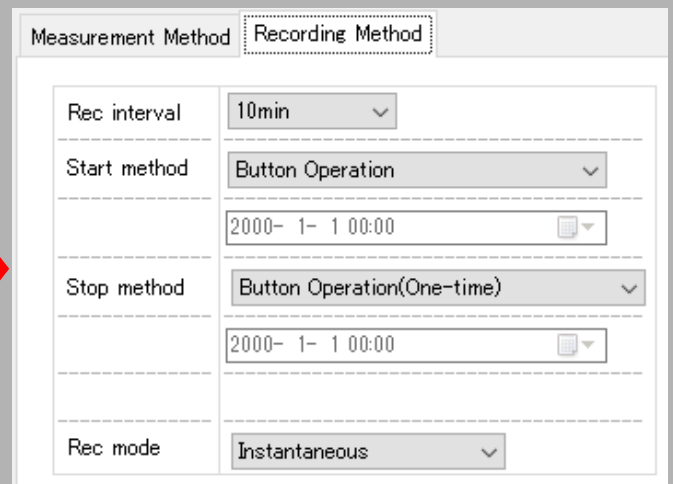
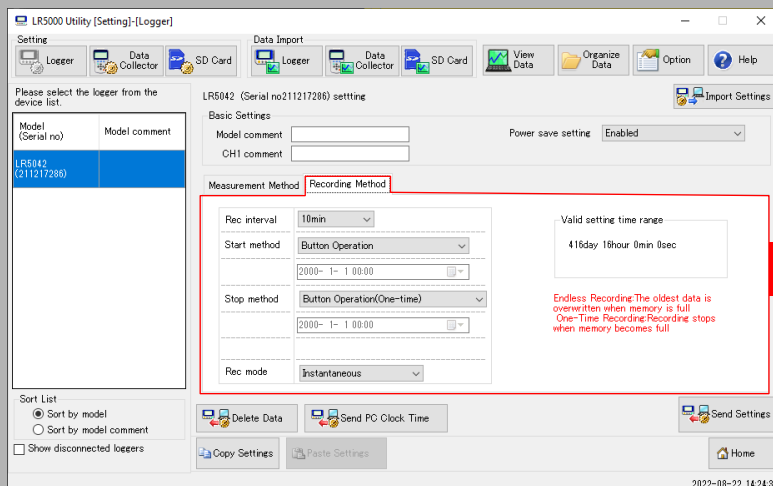

Some customers change the recording mode to statistical mode, but this mode needs a lot of battery power and drastically shortens the battery life of the PR-01 board and also the LR5041/LR5042. With the same settings, the battery life is about 1/4 of that of instantaneous value recording. Also, statistical mode requires the preheat function to be constantly running, so the PR-01 battery will consume much faster.

3. Click the measurement method tab to set preheat ON/OFF.

MIJ-12 Preheat-less Version: Set preheat to OFF

MIJ-12 Preheat Version: Set preheat to 1 sec as below

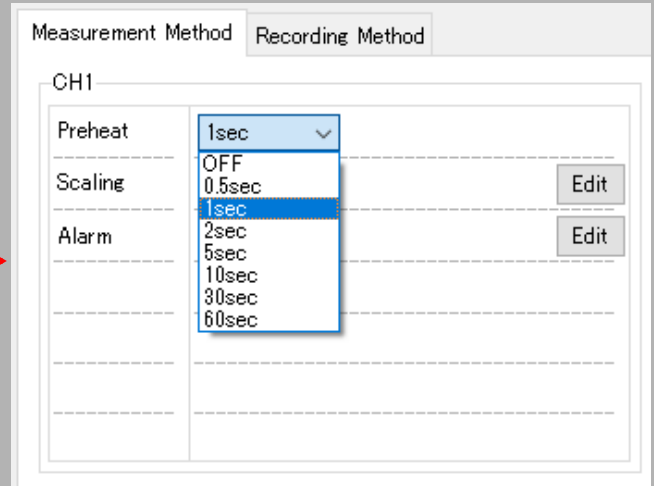
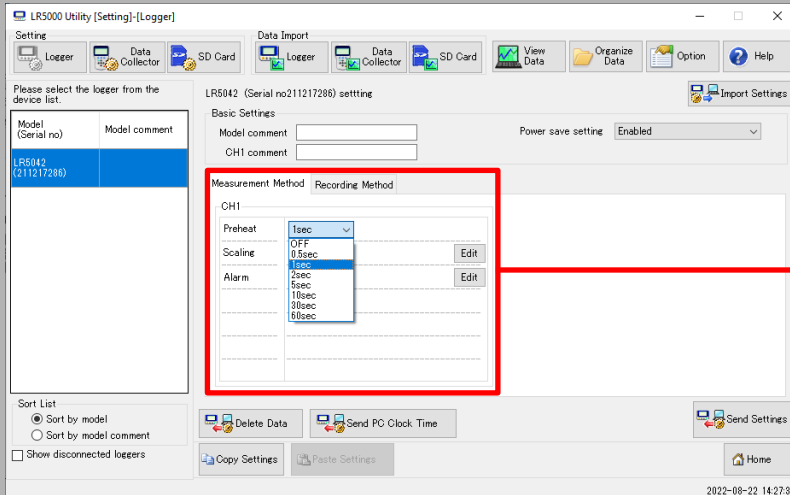

4. Finally, click the Submit Settings button to complete.

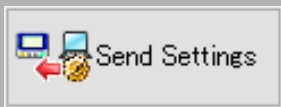

Logging Start, Stop, and Data collect

Start Logging

1. Place the sensor. Press and hold the Record/Stop (記録/停止) key until the "REC" on the display changes from flashing to steady

REC flashing

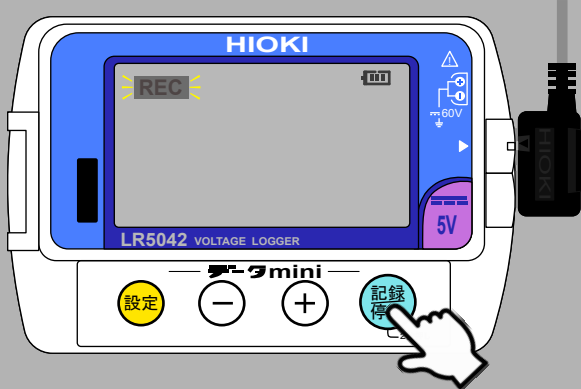

REC steady

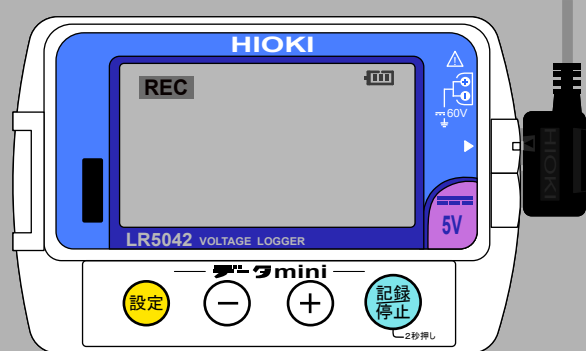

2.

The measurement screen will be displayed one second after the REC light turns to steady. This means that measurement has started normally. If the REC disappears from the display you have to try again.

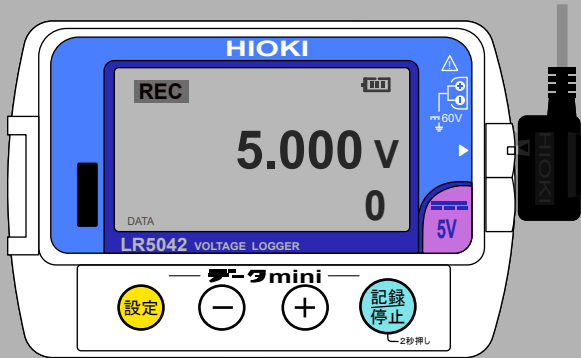

Stop Logging

Press and hold the Record/Stop key until "REC" flashes on the display and REC disappears from the display.

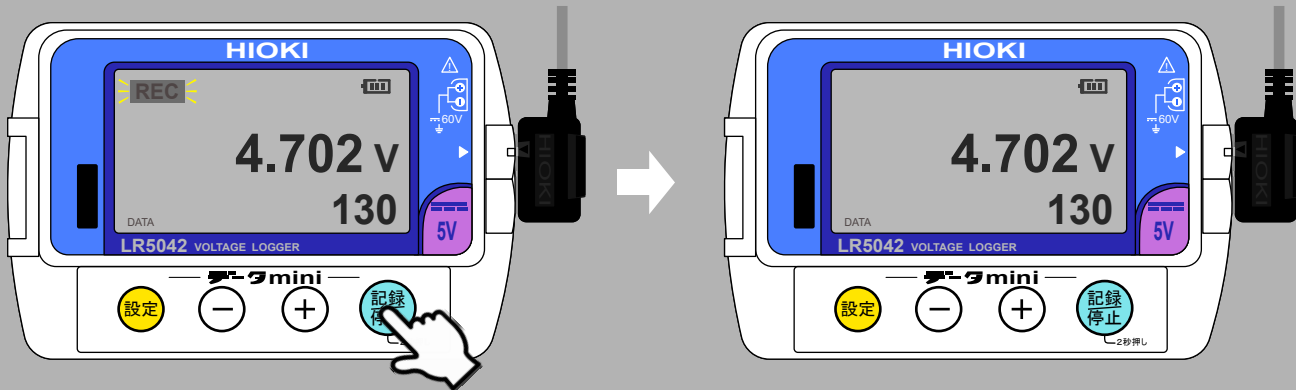

Data Collect

1.

Connect the LR5091 communications adapter to the PC and place the LR5041/5042 on top of the LR5091 communications adapter. (Place the LR5041/5042 with the DISPLAY side facing down.)

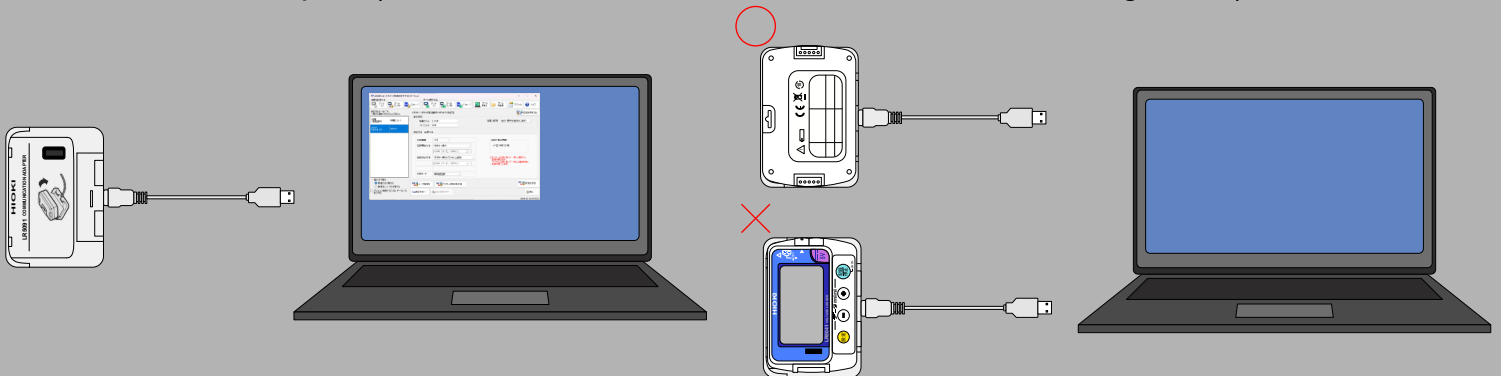

2.

Once step 1 is complete, a confirmation screen for importing data will be displayed. Select [Yes] if you want to import the data. For more detail please see the HIOKI manual

Trouble Shooting

Battery last only a few weeks

Is the preheat time set too long?

Although it depends on the sensor you are using, a preheat time of 1 second is generally fine. Some customers set the preheat time 10 minutes, but this unnecessarily shortens the battery life, so please change it to 1 second.

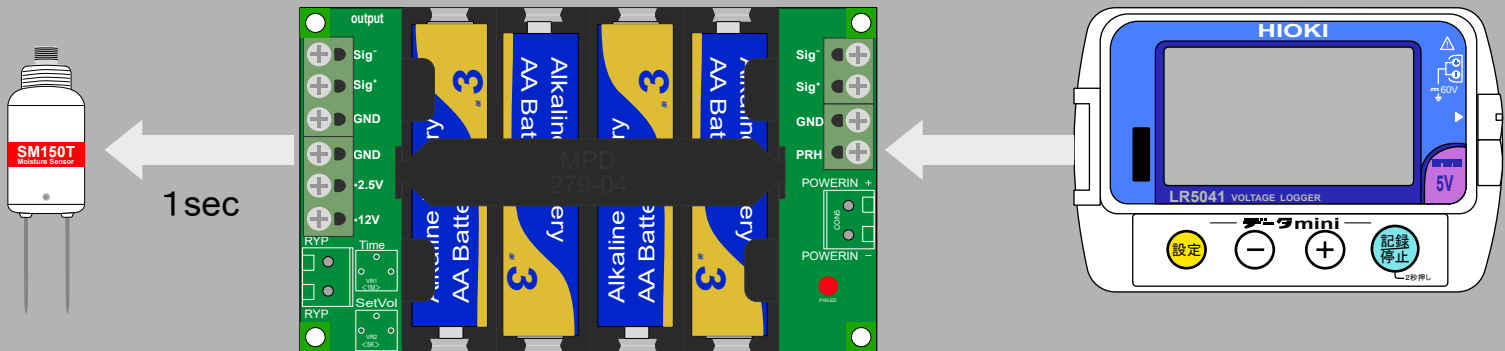

By setting the preheat time to 1 second on the LR5041/42, the PR-01 will stay running for 1 second = leading long battery life

Result: LR5041/42 and PR-01 batteries last a long time

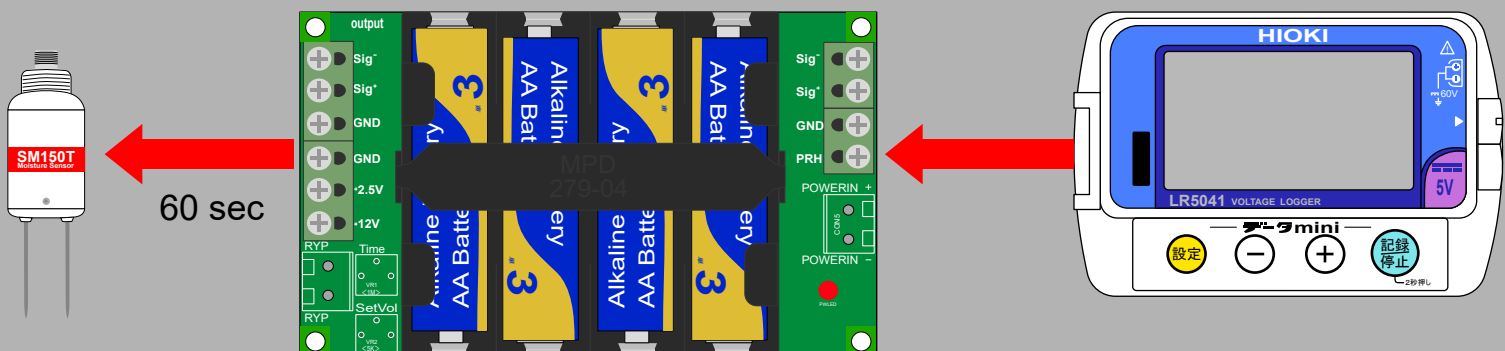

By setting the preheat time to 1 minute on the LR5041/42, the PR-01 will start up in 1 minute = battery life is 60 times faster than the above setting.

Result: The battery life of LR5041/42 and PR-01 will be shorter.

Is the LR5041/42 recording method set to record statistical values instead of instantaneous values?
For research purposes, it is not necessary to record statistical values, so we recommend recording instantaneous values. We recommend performing statistical processing on Excel.

Data not available

Did you check the operation before installing it?

If you are using the product for the first time, we recommend that you check its operation and perform preliminary tests before installation.

Press  lightly.

The display will be on for about one minute, so touch the sensor with your hand to check the response.
eg: soil moisture sensor

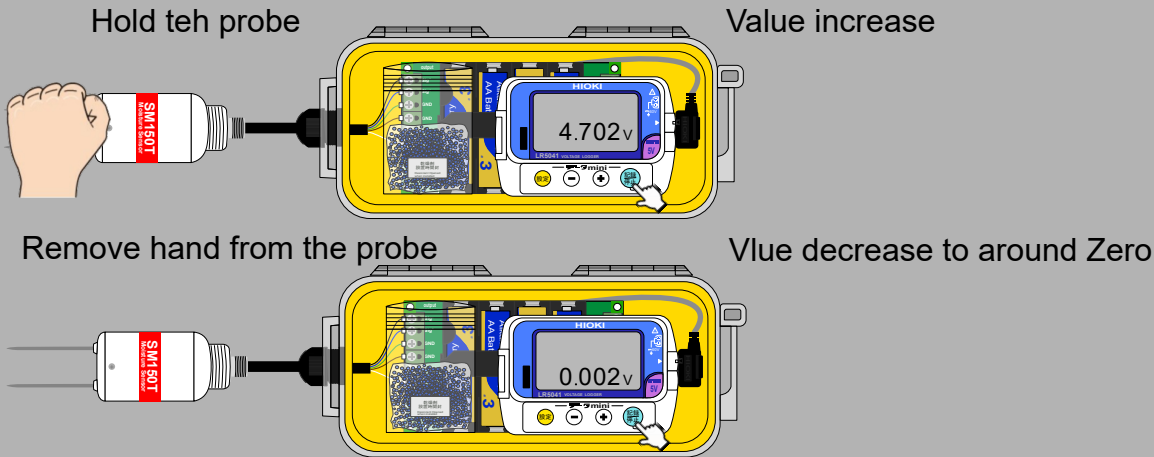

Is PR-01 broken?

- Is the battery polarity correct? (The + and - polarities of the batteries may have been inserted in the wrong direction by mistake.)

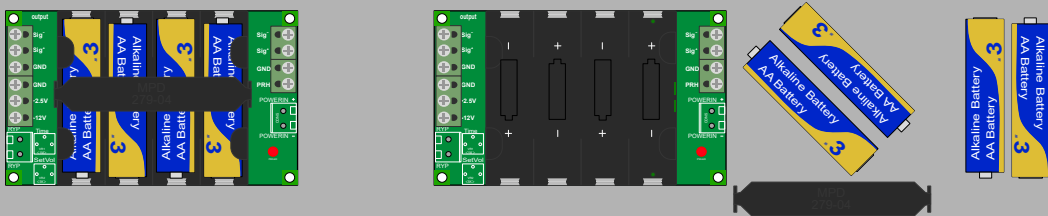

- Press the record button on the logger and let sensor to sense (for example, squeeze the pin in the case of a soil moisture meter). Does the PR-01 LED light up?

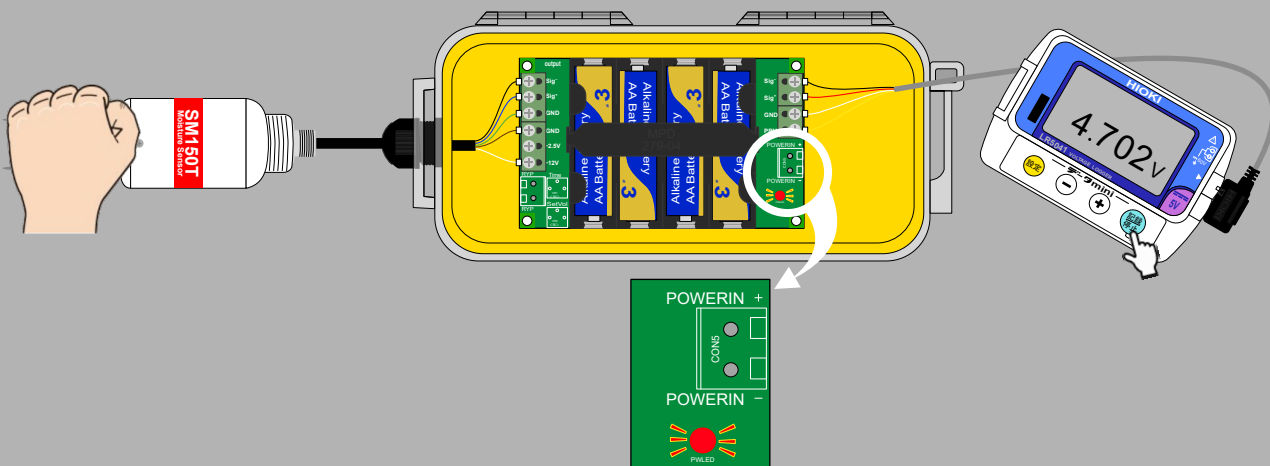

- Try Short circuit the GND and PRH terminals of the PR-01 with tweezers, etc. Does the LED light up ?

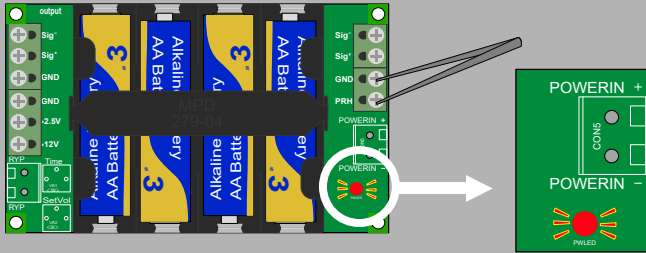

If there are no problems with all of the above, then the PR-01 is most likely not broken.

We also recommend replacement if you find any problems that can be determined from appearance, such as battery leakage or corrosion on the circuit board.

LR5041/5042 settings correct?

- Have you set the preheat setting to OFF even though the sensor requires preheat?

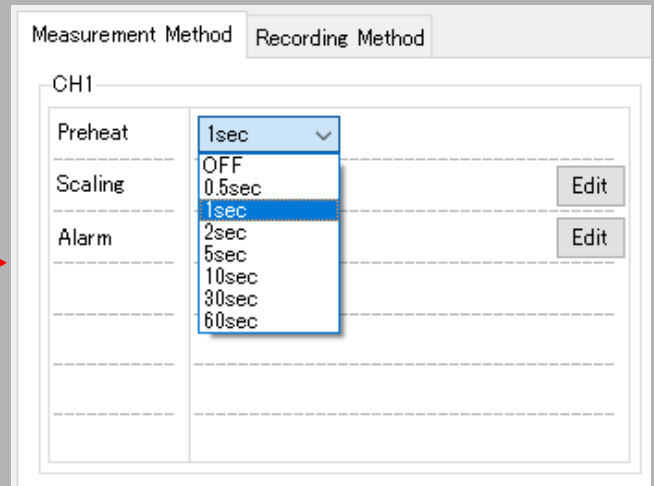
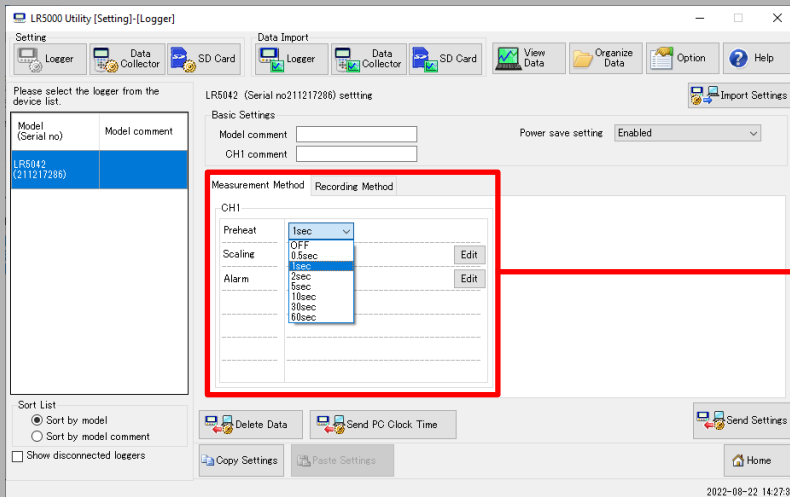

What is the remaining battery life of the LR5041/42?

- Please check the data logger batteries and PR-01 batteries

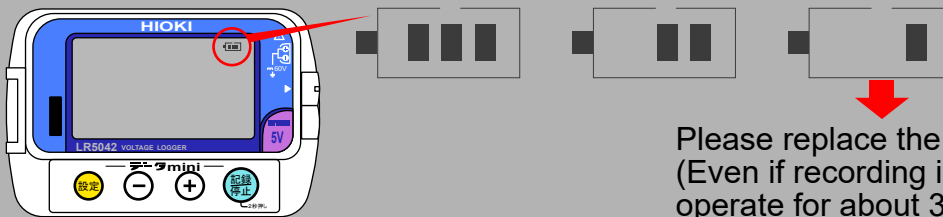

Please replace the battery as soon as possible.
(Even if recording is in progress, the device can still operate for about 30 seconds with the battery removed.)

Replacing the data logger battery: Refer to the Hioki manual for details.

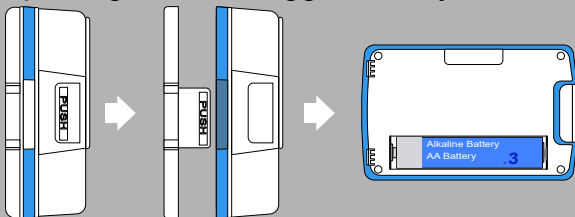

If you are unsure about the remaining battery power, press the PUSH button on the side of the logger to open the back cover and replace the battery. Some users replace the battery after about a year of measurement. It is a good idea to replace the PR-01 battery at the same time.

Output is Negative:

Please check that the included LR9802 cable is plugged in the correct direction.

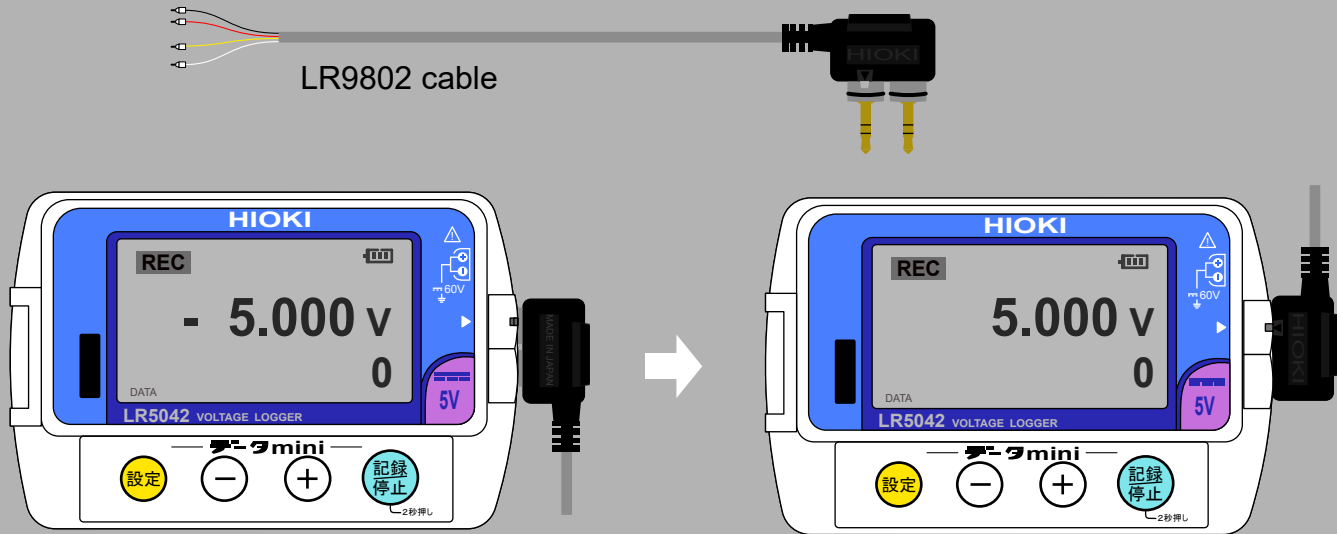

LR9802 connection cable is reversed

Please check that the wiring is correct.

If the sensor and LR9802 are not connected correctly as shown below, a negative value will be displayed.

